

dwarsdoorsnede

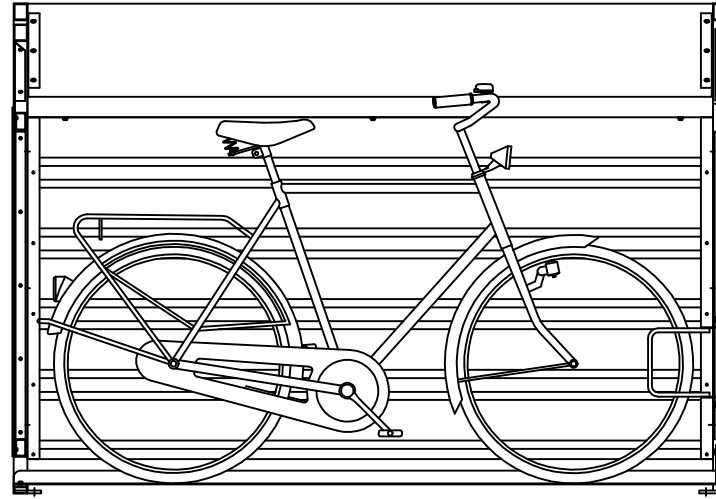

lengtedoorsnede

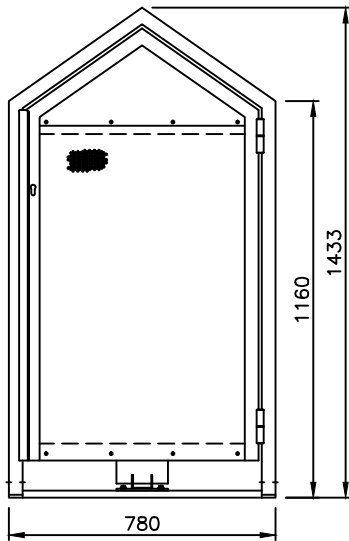

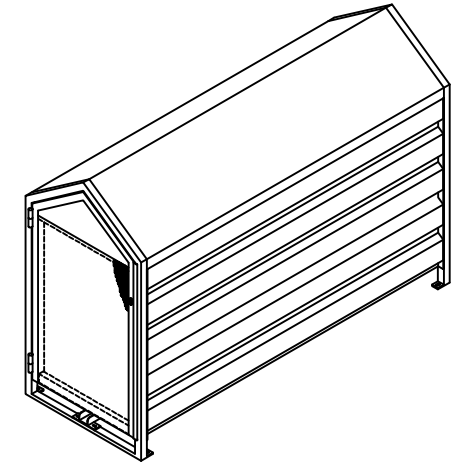

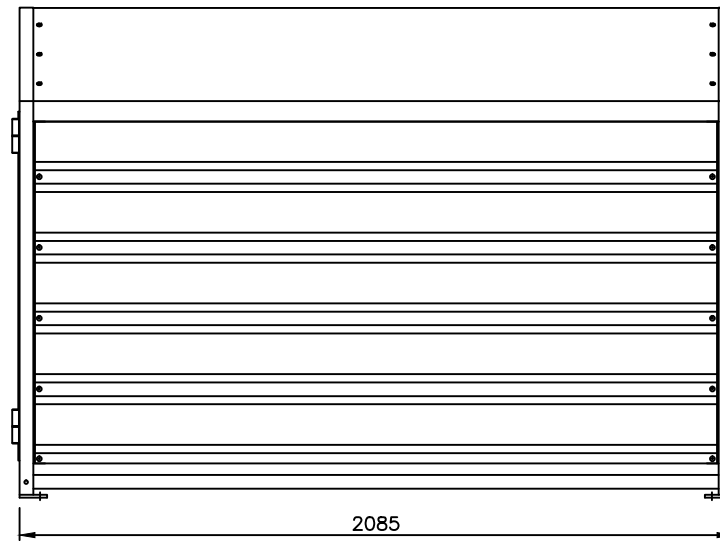
vooraanzicht

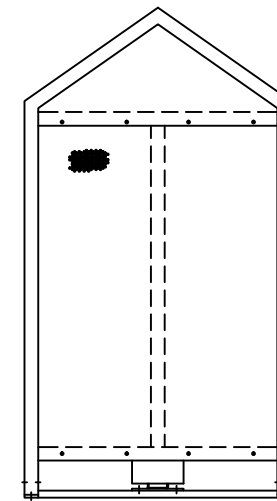

zij aanzicht



achteraanzicht

 Postbus 18 NL 7670AA Vriezenveen tel. 0546-534444 fax. 0546-561115	Wijzigingen		benaming	schaal	1:15	
	Datum	door		Art nr. 01.801.031	formaat	
	01-12-11	HZ		datum	08-03-96	
	-	-	opm.	getekend	G.S.	
	-	-	FalcoSafe fietskluis	cc verkoop	ja	
-	-	beginnelement, cilinder	extern	ja		
-	-		tekening nr.	01.801.031 VK		